



Luminaire

Lina35

35-500K-50GEE/840, S



The linear luminaires of the Lina35 family represent one of the thinnest profiles in our product range, while you can choose from several different lengths. The luminaires with direct distribution of light are available in the pendant, surface and recessed versions. Thanks to the option to extend and retract the opal diffuser, you can find the ideal combination of lights for a specific interior according to your needs. Thanks to this variability, Lina35 can be used in virtually all areas, but especially in the social, public and commercial ones. Luminaires with an extended diffuser diffuse their light into a significantly larger area thus helping to soften the entire interior.

Technical drawing

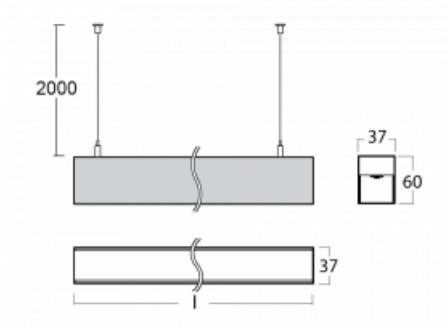

Type of installation	Suspended
Light distribution	Direct
Luminaire shape	Linear
Colour of the luminaires	Silver
Material	Aluminium
Lifetime	L90/B50 50 000 hours
Warranty	5 years
Description of luminaires	Luminaire suspended
Dimensions	2805 mm × 37 mm × 60 mm
Weight	4.5 kg
Light source	LED MODUL
Type of optical system	Opal diffuser
Luminous flux*	3640 lm
Colour Temperature	4000 K cool white
Luminous efficacy	94 lm/W
MacAdam Light source	2
Colour rendering index	80
UGR max. X=4H Y=8H, $\rho=70,50,20$	25.3

Curve



Luminaire power input* 38.6 W

Connection of the luminaires ON/OFF

Electrical voltage 220-240V

Frequency 50/60Hz

⊕ CE IP 20

*±10 %

Downloads

Installation instructions



Photos

