



Luminaire

Lina28

28-501Z-40GEE/830, S



The Lina28 luminaire with direct or direct-indirect light distribution is the thinnest linear luminaire in our product range. It is made of highquality aluminium profile and the luminaire also includes an electronic ballast, which does not need to be placed outside the luminaire, as is usual with such thin profiles. The luminaire features an integrated optical louver, which ensures low values of the UGR parameter, or, as an alternative option, an opal diffuser made of PMMA material which guarantees a premium UV stability. All of this makes the pendant luminaire suitable for offices, corridors, social spaces or whenever a minimalist design is required. Share

Technical drawing



Type of installation	Suspended
Light distribution	Direct-indirect
Luminaire shape	Linear
Colour of the luminaires	Silver
Material	Aluminium
Lifetime	L80/B20 50 000 hours
Warranty	5 years
Description of luminaires	Luminaire suspended
Dimensions	2249 mm × 28 mm × 61 mm
Weight	3.6 kg
Light source	LED MODUL
Type of optical system	Plastic louvre low UGR
Luminous flux*	7750 lm
Colour Temperature	3000 K warm white
Luminous efficacy	120 lm/W
MacAdam Light source	3
Colour rendering index	80
UGR max. X=4H Y=8H, $\rho=70,50,20$	12.2

Curve

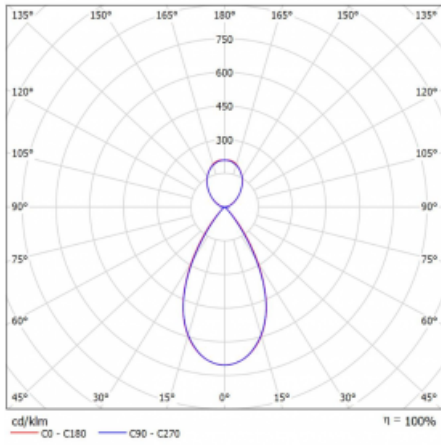

Luminaire power input* 64.5 W

Connection of the luminaires ON/OFF

Electrical voltage 220-240V

Frequency 50/60Hz

⊕ CE IP 20

*±10 %

Downloads

Installation instructions



Photos

