



Luminaire

Rotao60

227-581K-10GEE/840, W



The designer circular luminaire Rotao60 comes in a large number of diameters, thanks to which it fits well into various social and commercial spaces. You can also use it to decorate your living room or a meeting room. If you combine the luminaire with microprismatic optics, its efficacy can be surprising even in an office. Pendant versions of the Rotao60 luminaire with a diameter of up to 800 mm are suspended on suspension wires which converge into a single ceiling cup, while larger diameters are suspended on wires that run perpendicular to the ceiling.

Technical drawing

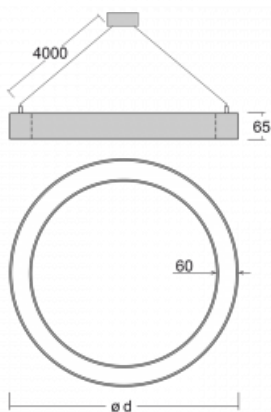

Type of installation	Suspended
Light distribution	Direct-indirect
Luminaire shape	Circular
Colour of the luminaires	White
Material	Aluminium
Lifetime	L80/B20 50 000 hours
Warranty	5 years
Description of luminaires	Luminaire suspended
Dimensions	ø 800 mm × 65 mm
Weight	4.5 kg
Light source	LED MODUL
Type of optical system	Opal diffuser
Luminous flux*	4450 lm
Colour Temperature	4000 K cool white
Luminous efficacy	116 lm/W
MacAdam Light source	3
Colour rendering index	80
UGR max. X=4H Y=8H, $\rho=70,50,20$	22.3

Curve



Luminaire power input* 38.2 W

Connection of the luminaires ON/OFF

Electrical voltage 220-240V

Frequency 50/60Hz

⊕ CE IP 20

* $\pm 10\%$

Downloads

Installation instructions



Photos

