



Luminaire

Rundo 62

190-261I-10GGQ/TC, W

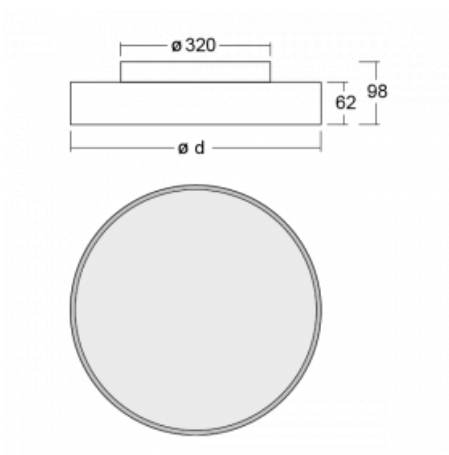

Circular luminaires with an aluminium profile come in height 62 mm feature an excellent efficacy of up to 145 lm/W, which can give the space lightness and appeal. The luminaires are pendant or flush-mounted, with direct or direct-indirect distribution of light creating an interesting light halo. A circular luminaire with a PMMA opal diffuser or microprismatic optical system is suitable for both commercial spaces and households. A playful and interesting effect can be created by combining different diameters. Luminaires can be equipped with a motion sensor, daylight sensor or Bluetooth technology, which allows easy control of the luminaire from your smart device.

Technical drawing

Type of installation	Surface, Wall mounted
Light distribution	Direct-indirect
Luminaire shape	Circular
Colour of the luminaires	White
Material	Aluminium
Lifetime	L80/B20 50 000 hours
Warranty	5 years
Description of luminaires	Luminaire surface/wall mounted
Dimensions	\varnothing 600 mm \times 62 mm
Weight	6.5 kg
Light source	LED MODUL
DIR optical system	Microprisma
INDIR optical system	Opal cover
Luminous flux*	3330 lm
Colour Temperature	2700 K - 6500 K Tunable White
Luminous efficacy	81 lm/W
MacAdam Light source	3
Colour rendering index	90

Curve



Luminaire power input* 40.9 W

Connection of the luminaires DALI DT8

Electrical voltage 220-240V

Frequency 50/60Hz

⊕ CE IP 40

*±10 %

Downloads

Installation instructions



Photos

