



Luminaire

Vali80-T

179-605S-10GHE/940, S



We have managed to minimize the dimensions of the Vali80-T luminaires while maintaining very good lighting parameters. We also managed to reduce the casing of the luminaire to 75% of the surface. The luminaires offer a direct type of light distribution, four different beam angles of 18°, 25°, 32°, 52° and replaceable reflectors as optional accessories. The luminaires will be used predominantly to illuminate commercial spaces, galleries or showrooms. The luminaires have been fitted with adapters for the 3-phase Global Track from Nordic Aluminium. Vali80-T uses light sources with a colour rendering index of Ra90, which helps to show the true colours of the illuminated objects.

Technical drawing

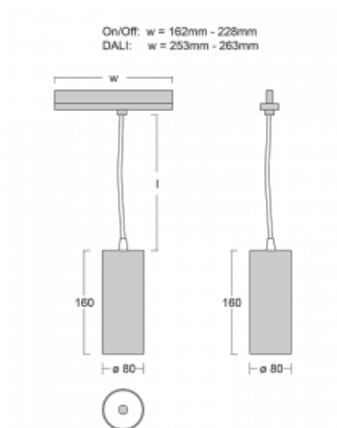

Type of installation	3 circuit track
Light distribution	Direct
Luminaire shape	Circular
Colour of the luminaires	Silver
Material	Aluminium
Lifetime	L80/B10 60 000 hours
Warranty	5 years
Description of luminaires	Luminaire 3 circuit track
Dimensions	ø 80 mm × 160 mm
Weight	0.7 kg
Light source	LED MODUL

DIR optical system	Reflector
Luminous flux*	2970 lm
Colour Temperature	4000 K cool white
Luminous efficacy	90 lm/W
MacAdam Light source	3
Colour rendering index	90

Luminaire power input*	33 W
Connection of the luminaires	ON/OFF
Electrical voltage	220-240V
Frequency	50/60Hz

 **CE** IP 20

*±10 %

Downloads

Installation instructions



Photos



Accessories

00-00300, N
 wire suspension
 2000mm

00-00301, N
 wire suspension
 4000mm

00-00302, N
 wire suspension
 6000mm

00-00363, K
 cable 5x1,5 2000mm

00-00364, K
 cable 5x1,5 4000mm

00-00365, K
 cable 5x1,5 6000mm

00-00370, B
 ceiling cup 80x80x32mm

00-00370, S
 ceiling cup 80x80x32mm

00-00370, W
 ceiling cup 80x80x32mm

SKB10-1, grey
 Track clamp, grey

SKB10-2, black
 Track clamp, black

SKB10-3, white
 Track clamp, white

SKB12-1, grey
 Track clamp, grey

SKB12-2, black
 Track clamp, black

SKB12-3, white
 Track clamp, white

XTAK11-1, grey
 Hook, grey

XTAK142-1, grey
 Hook Base, grey

XTAK142-2, black
 Hook Base, black

XTAK142-3, white
 Hook Base 2mm wire,
 white

XTS11-1, grey
 End feed, grey

XTS11-2, black
 End feed, black

XTS11-3, white
 End feed, white

XTS12-1, grey
 End feed, grey

XTS12-2, black
 End feed, black

XTS12-3, white
 End feed, white

XTS14-1, grey
 Middle feed, grey

XTS14-2, black
 Middle feed, black

XTS14-3, white
 Middle feed, white

XTS21-1, grey
 Straight connector, grey

XTS21-2, black
 Straight connector,
 black

XTS21-3, white
 Straight connector,
 white

XTS24-1, grey
 Adjustable corner
 connector, grey

XTS24-2, black
 Adjustable corner
 connector, black

XTS24-3, white
 Adjustable corner
 connector, white

XTS34-1, grey
 L-feed, grey

XTS34-2, black
 L-feed, black

XTS34-3, white
 L-feed, white

XTS35-1, grey
 L-feed, grey

XTS35-2, black
 L-feed, black

XTS35-3, white
 L-feed, white

XTS36-1, grey
 T-feed, grey

XTS36-2, black
 T-feed, black



XTS36-3, white
T-feed, white



XTS37-1, grey
T-feed, grey



XTS37-2, black
T-feed, black



XTS37-3, white
T-feed, white



XTS38-1, grey
X-feed, grey



XTS38-2, black
X-feed, black



XTS38-3, white
X-feed, bílá



XTS39-1, grey
T-feed, grey



XTS39-2, black
T-feed, black



XTS39-3, white
T-feed, white



XTS40-1, grey
T-feed, grey



XTS40-2, black
T-feed, black



XTS40-3, white
T-feed, white



XTS41-1, grey
End Cap, grey



XTS41-2, black
End Cap, black



XTS41-3, white
End Cap, white



XTS4100-1, grey
linear track 1m, grey



XTS4100-2, black
linear track 1m, black



XTS4100-3, white
linear track 1m, white



XTS4200-1, grey
linear track 2m, grey



XTS4200-2, black
linear track 2m, black



XTS4200-3, white
linear track 2m, white



XTS4300-1, grey
linear track 3m, grey



XTS4300-2, black
linear track 3m, black



XTS4300-3, white
linear track 3m, white



XTS4400-1, grey
linear track 4m, grey



XTS4400-2, black
linear track 4m, black



XTS4400-3, white
linear track 4m, white



XTSF4100-1, grey
recessed linear track 1m, grey

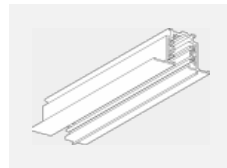

XTSF4100-2, black
recessed linear track 1m, black



XTSF4100-3, white
recessed linear track 1m, white



XTSF4200-1, grey
recessed linear track 2m, grey



XTSF4200-2, black
recessed linear track 2m, black



XTSF4200-3, white
recessed linear track 2m, white



XTSF4300-1, grey
recessed linear track 3m, grey



XTSF4300-2, black
recessed linear track 3m, black

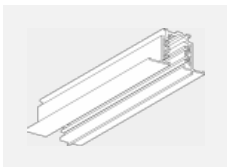

XTSF4300-3, white
recessed linear track 3m, white

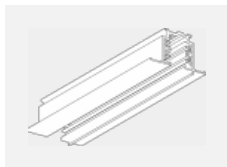

XTSF4400-1, grey
recessed linear track 4m, grey

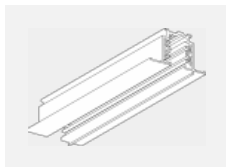

XTSF4400-2, black
recessed linear track 4m, black

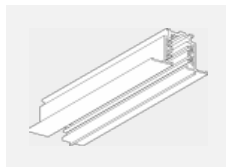

XTSF4400-3, white
recessed linear track 4m, white

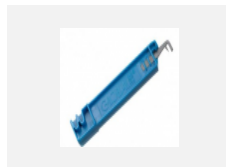

XTSV12-1, grey
Bending tool for track power wires