



**Luminaire**

# Vali80-T

179-605S-10GDE/940, B

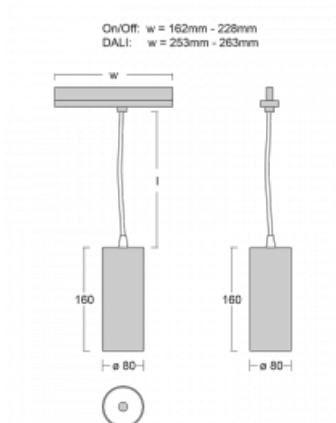

We have managed to minimize the dimensions of the Vali80-T luminaires while maintaining very good lighting parameters. We also managed to reduce the casing of the luminaire to 75% of the surface. The luminaires offer a direct type of light distribution, four different beam angles of 18°, 25°, 32°, 52° and replaceable reflectors as optional accessories. The luminaires will be used predominantly to illuminate commercial spaces, galleries or showrooms. The luminaires have been fitted with adapters for the 3-phase Global Track from Nordic Aluminium. Vali80-T uses light sources with a colour rendering index of Ra90, which helps to show the true colours of the illuminated objects.

**Technical drawing**

Type of installation	3 circuit track
Light distribution	Direct
Luminaire shape	Circular
Colour of the luminaires	Black
Material	Aluminium
Lifetime	L90/B50 60 000 hours
Warranty	5 years
Description of luminaires	Luminaire 3 circuit track
Dimensions	ø 80 mm × 160 mm
Weight	0.7 kg
Light source	LED MODUL

DIR optical system	Reflector
Luminous flux*	1040 lm
Colour Temperature	4000 K cool white
Luminous efficacy	104 lm/W
MacAdam Light source	3
Colour rendering index	90

Luminaire power input*	10 W
Connection of the luminaires	ON/OFF
Electrical voltage	220-240V
Frequency	50/60Hz

**IP 20**

\*±10 %

## Downloads

Installation instructions



Photos



**Accessories**

**00-00300, N**  
 wire suspension  
 2000mm

**00-00301, N**  
 wire suspension  
 4000mm

**00-00302, N**  
 wire suspension  
 6000mm

**00-00363, K**  
 cable 5x1,5 2000mm

**00-00364, K**  
 cable 5x1,5 4000mm

**00-00365, K**  
 cable 5x1,5 6000mm

**00-00370, B**  
 ceiling cup 80x80x32mm

**00-00370, S**  
 ceiling cup 80x80x32mm

**00-00370, W**  
 ceiling cup 80x80x32mm

**SKB10-1, grey**  
 Track clamp, grey

**SKB10-2, black**  
 Track clamp, black

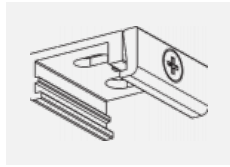
**SKB10-3, white**  
 Track clamp, white

**SKB12-1, grey**  
 Track clamp, grey

**SKB12-2, black**  
 Track clamp, black

**SKB12-3, white**  
 Track clamp, white

**XTAK11-1, grey**  
 Hook, grey

**XTAK142-1, grey**  
 Hook Base, grey

**XTAK142-2, black**  
 Hook Base, black

**XTAK142-3, white**  
 Hook Base 2mm wire,  
 white

**XTS11-1, grey**  
 End feed, grey

**XTS11-2, black**  
 End feed, black

**XTS11-3, white**  
 End feed, white

**XTS12-1, grey**  
 End feed, grey

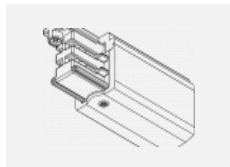
**XTS12-2, black**  
 End feed, black

**XTS12-3, white**  
 End feed, white

**XTS14-1, grey**  
 Middle feed, grey

**XTS14-2, black**  
 Middle feed, black

**XTS14-3, white**  
 Middle feed, white

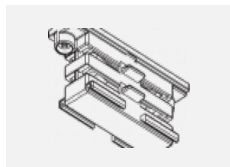
**XTS21-1, grey**  
 Straight connector, grey

**XTS21-2, black**  
 Straight connector,  
 black

**XTS21-3, white**  
 Straight connector,  
 white

**XTS24-1, grey**  
 Adjustable corner  
 connector, grey

**XTS24-2, black**  
 Adjustable corner  
 connector, black

**XTS24-3, white**  
 Adjustable corner  
 connector, white

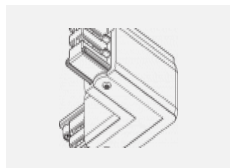
**XTS34-1, grey**  
 L-feed, grey

**XTS34-2, black**  
 L-feed, black

**XTS34-3, white**  
 L-feed, white

**XTS35-1, grey**  
 L-feed, grey

**XTS35-2, black**  
 L-feed, black

**XTS35-3, white**  
 L-feed, white

**XTS36-1, grey**  
 T-feed, grey

**XTS36-2, black**  
 T-feed, black



**XTS36-3, white**  
T-feed, white



**XTS37-1, grey**  
T-feed, grey



**XTS37-2, black**  
T-feed, black



**XTS37-3, white**  
T-feed, white



**XTS38-1, grey**  
X-feed, grey



**XTS38-2, black**  
X-feed, black



**XTS38-3, white**  
X-feed, bílá



**XTS39-1, grey**  
T-feed, grey



**XTS39-2, black**  
T-feed, black



**XTS39-3, white**  
T-feed, white



**XTS40-1, grey**  
T-feed, grey



**XTS40-2, black**  
T-feed, black



**XTS40-3, white**  
T-feed, white



**XTS41-1, grey**  
End Cap, grey



**XTS41-2, black**  
End Cap, black



**XTS41-3, white**  
End Cap, white



**XTS4100-1, grey**  
linear track 1m, grey



**XTS4100-2, black**  
linear track 1m, black



**XTS4100-3, white**  
linear track 1m, white



**XTS4200-1, grey**  
linear track 2m, grey



**XTS4200-2, black**  
linear track 2m, black



**XTS4200-3, white**  
linear track 2m, white



**XTS4300-1, grey**  
linear track 3m, grey



**XTS4300-2, black**  
linear track 3m, black



**XTS4300-3, white**  
linear track 3m, white



**XTS4400-1, grey**  
linear track 4m, grey



**XTS4400-2, black**  
linear track 4m, black



**XTS4400-3, white**  
linear track 4m, white



**XTSF4100-1, grey**  
recessed linear track 1m,  
grey



**XTSF4100-2, black**  
recessed linear track 1m,  
black



**XTSF4100-3, white**  
recessed linear track 1m,  
white



**XTSF4200-1, grey**  
recessed linear track 2m,  
grey



**XTSF4200-2, black**  
recessed linear track 2m,  
black



**XTSF4200-3, white**  
recessed linear track 2m,  
white



**XTSF4300-1, grey**  
recessed linear track 3m,  
grey



**XTSF4300-2, black**  
recessed linear track 3m,  
black



**XTSF4300-3, white**  
recessed linear track 3m,  
white



**XTSF4400-1, grey**  
recessed linear track 4m,  
grey



**XTSF4400-2, black**  
recessed linear track 4m,  
black



**XTSF4400-3, white**  
recessed linear track 4m,  
white



**XTSV12-1, grey**  
Bending tool for track  
power wires