



## Luminaire

# Drob-T

177-600S-10GGE/940, B



A dimmable, tilting track luminaire, whose shape is slightly reminiscent of headlights used on vintage cars. It features highbrightness LEDs with colour rendering of  $Ra > 80$  or  $Ra > 90$ , transparent plexiglass or satin diffuser. The luminaires use adapters for the Global Track three-circuit tracks. Thanks to their minimalist design, they have lower luminous fluxes and are therefore more suitable for smaller shops with lower ceilings, such as drugstores or pharmacies. However, they can also be used in bars or less formal lobbies.

## Technical drawing

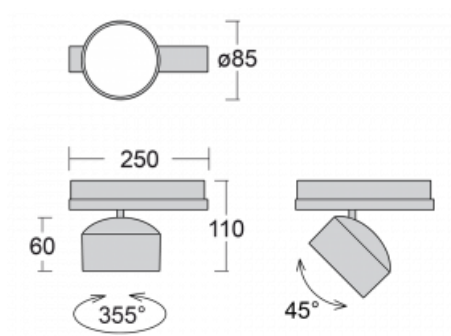

|   |   |
|---|---|
| Type of installation                      | 3 circuit track                                   |
| Light distribution                        | Direct  |
| Luminaire shape                           | Circular  |
| Colour of the luminaires                  | Black   |
| Material                                  | Aluminium   |
| Lifetime                                  | L80/B20 50 000 hours                              |
| Warranty                                  | 5 years   |
| Description of luminaires                 | Luminaire 3 circuit track                         |
| Dimensions                                | $\varnothing 85 \text{ mm} \times 110 \text{ mm}$ |
| Weight                                    | 0.45 kg   |
| Light source                              | LED MODUL   |
| Type of optical system                    | Reflector   |
| Luminous flux*                            | 2000 lm   |
| Colour Temperature                        | 4000 K cool white                                 |
| Luminous efficacy                         | 120 lm/W  |
| MacAdam Light source                      | 3   |
| Colour rendering index                    | 90  |
| Beam angle                                | $18^\circ$  |
| UGR max. X=4H<br>Y=8H, $\varrho=70,50,20$ | 18.4  |

## Curve



Luminaire power input\* 16.7 W

Connection of the luminaires ON/OFF

Electrical voltage 220-240V

Frequency 50/60Hz

 **CE** IP 20

\* $\pm 10\%$

## Downloads

Installation instructions



Photos



**Accessories**

**00-00300, N**  
 wire suspension  
 2000mm

**00-00301, N**  
 wire suspension  
 4000mm

**00-00302, N**  
 wire suspension  
 6000mm

**00-00363, K**  
 cable 5x1,5 2000mm

**00-00364, K**  
 cable 5x1,5 4000mm

**00-00365, K**  
 cable 5x1,5 6000mm

**00-00370, B**  
 ceiling cup 80x80x32mm

**00-00370, S**  
 ceiling cup 80x80x32mm

**00-00370, W**  
 ceiling cup 80x80x32mm

**SKB10-1, grey**  
 Track clamp, grey

**SKB10-2, black**  
 Track clamp, black

**SKB10-3, white**  
 Track clamp, white

**SKB12-1, grey**  
 Track clamp, grey

**SKB12-2, black**  
 Track clamp, black

**SKB12-3, white**  
 Track clamp, white

**XTAK11-1, grey**  
 Hook, grey

**XTAK142-1, grey**  
 Hook Base, grey

**XTAK142-2, black**  
 Hook Base, black

**XTAK142-3, white**  
 Hook Base 2mm wire,  
 white

**XTS11-1, grey**  
 End feed, grey

**XTS11-2, black**  
 End feed, black

**XTS11-3, white**  
 End feed, white

**XTS12-1, grey**  
 End feed, grey

**XTS12-2, black**  
 End feed, black

**XTS12-3, white**  
 End feed, white

**XTS14-1, grey**  
 Middle feed, grey

**XTS14-2, black**  
 Middle feed, black

**XTS14-3, white**  
 Middle feed, white

**XTS21-1, grey**  
 Straight connector, grey

**XTS21-2, black**  
 Straight connector, black

**XTS21-3, white**  
 Straight connector, white

**XTS24-1, grey**  
 Adjustable corner  
 connector, grey

**XTS24-2, black**  
 Adjustable corner  
 connector, black

**XTS24-3, white**  
 Adjustable corner  
 connector, white

**XTS34-1, grey**  
 L-feed, grey

**XTS34-2, black**  
 L-feed, black

**XTS34-3, white**  
 L-feed, white

**XTS35-1, grey**  
 L-feed, grey

**XTS35-2, black**  
 L-feed, black

**XTS35-3, white**  
 L-feed, white

**XTS36-1, grey**  
 T-feed, grey

**XTS36-2, black**  
 T-feed, black



**XTS36-3, white**  
T-feed, white



**XTS37-1, grey**  
T-feed, grey



**XTS37-2, black**  
T-feed, black



**XTS37-3, white**  
T-feed, white



**XTS38-1, grey**  
X-feed, grey



**XTS38-2, black**  
X-feed, black



**XTS38-3, white**  
X-feed, bílá



**XTS39-1, grey**  
T-feed, grey



**XTS39-2, black**  
T-feed, black



**XTS39-3, white**  
T-feed, white



**XTS40-1, grey**  
T-feed, grey



**XTS40-2, black**  
T-feed, black



**XTS40-3, white**  
T-feed, white



**XTS41-1, grey**  
End Cap, grey



**XTS41-2, black**  
End Cap, black



**XTS41-3, white**  
End Cap, white



**XTS4100-1, grey**  
linear track 1m, grey



**XTS4100-2, black**  
linear track 1m, black



**XTS4100-3, white**  
linear track 1m, white



**XTS4200-1, grey**  
linear track 2m, grey



**XTS4200-2, black**  
linear track 2m, black



**XTS4200-3, white**  
linear track 2m, white



**XTS4300-1, grey**  
linear track 3m, grey



**XTS4300-2, black**  
linear track 3m, black



**XTS4300-3, white**  
linear track 3m, white



**XTS4400-1, grey**  
linear track 4m, grey



**XTS4400-2, black**  
linear track 4m, black



**XTS4400-3, white**  
linear track 4m, white



**XTSF4100-1, grey**  
recessed linear track 1m, grey



**XTSF4100-2, black**  
recessed linear track 1m, black



**XTSF4100-3, white**  
recessed linear track 1m, white



**XTSF4200-1, grey**  
recessed linear track 2m, grey



**XTSF4200-2, black**  
recessed linear track 2m, black



**XTSF4200-3, white**  
recessed linear track 2m, white



**XTSF4300-1, grey**  
recessed linear track 3m, grey



**XTSF4300-2, black**  
recessed linear track 3m, black



**XTSF4300-3, white**  
recessed linear track 3m, white



**XTSF4400-1, grey**  
recessed linear track 4m, grey



**XTSF4400-2, black**  
recessed linear track 4m, black



**XTSF4400-3, white**  
recessed linear track 4m, white



**XTSV12-1, grey**  
Bending tool for track power wires