

## Luminaire

145-5C1K-20GHE/840, W



EPD®

Imagine a linear luminaire that can satisfy all your needs: it meets UGR, has high efficiency and you can build it to your specifications. And it looks great too. The Lina45 offers opal, microprism and optical louvre variants, so it can easily meet both UGR under 19 at 4300 lm luminous flux. It is a great solution for visually demanding spaces, as it even meets UGR under 16 in some variants. The indirect lighting component is provided by a clear plexi option or a wide-lighting diffuser (batwing distribution), which creates more even ceiling illumination.

## Technical drawing

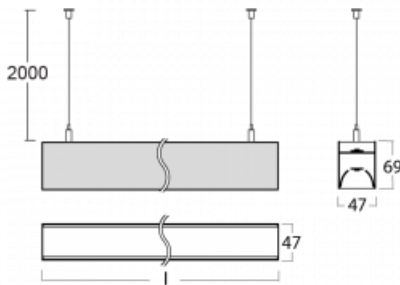

## Curve

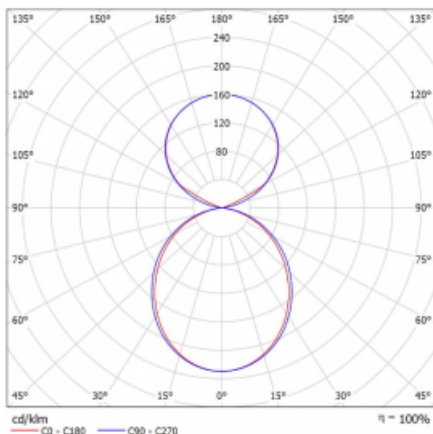

Type of installation	Suspended
Light distribution	Direct-indirect
Luminaire shape	Linear
Colour of the luminaires	White
Material	Aluminium
Lifetime	L80/B20 50 000 hours
Warranty	5 years
Description of luminaires	Luminaire suspended
item description	D/I - 57/43, White ceiling cup and cable
Dimensions (l × w × h mm)	1130 mm × 47 mm × 69 mm
Light source	LED MODUL
DIR optical system	Opal diffuser
INDIR optical system	Celar cover
Luminous flux*	6830 lm
Colour Temperature	4000 K cool white
Luminous efficacy	157 lm/W
MacAdam Light source	3
Colour rendering index	80
UGR max. X=4H Y=8H, ρ=70,50,20	24.3

Luminaire power input*	43.6 W
Connection of the luminaires	ON/OFF
Electrical voltage	220-240V
Frequency	50/60Hz

  IP 20

\*±10 %

## Downloads

Installation instructions



Photos

