



Luminaire

Lina45

145-5C0I-15GGD/840, W



EPD®

Imagine a linear luminaire that can satisfy all your needs: it meets UGR, has high efficiency and you can build it to your specifications. And it looks great too. The Lina45 offers opal, microprism and optical louvre variants, so it can easily meet both UGR under 19 at 4300 lm luminous flux. It is a great solution for visually demanding spaces, as it even meets UGR under 16 in some variants. The indirect lighting component is provided by a clear plexi option or a wide-lighting diffuser (batwing distribution), which creates more even ceiling illumination.

Technical drawing

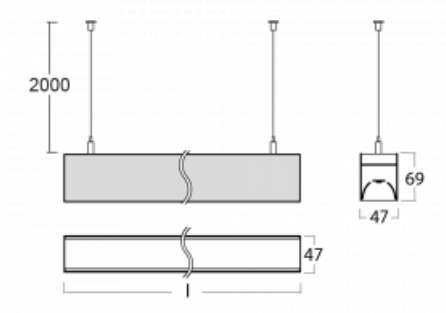

Type of installation	Suspended
Light distribution	Direct
Luminaire shape	Linear
Colour of the luminaires	White
Material	Aluminium
Lifetime	L80/B20 50 000 hours
Warranty	5 years
Description of luminaires	Luminaire suspended
Dimensions	847 mm × 47 mm × 69 mm
Light source	LED MODUL
Type of optical system	Microprisma
Luminous flux*	1710 lm
Colour Temperature	4000 K cool white
Luminous efficacy	140 lm/W
MacAdam Light source	3
Colour rendering index	80
UGR max. X=4H Y=8H, ρ=70,50,20	22.4

Curve



Luminaire power input* 12.2 W

Connection of the luminaires DALI

Electrical voltage 220-240V

Frequency 50/60Hz

⊕ CE IP 20

*±10 %

Downloads

Installation instructions



Photos

