



Luminaire

Puri

143-030I-10GED/840, W



We were thinking about how to achieve design purity, so we created a family of Puri recessed circular luminaires. Choose between the framed and frameless versions. You can mount it directly into the ceiling, without any cables or suspension fixtures. The framed version has a great advantage as it is very easy to disassemble. Using various diameters of the ceiling light, you can create combinations that will best suit the needs of your commercial spaces, offices, hotels or corridors. Puri blends in with the interior and can be easily combined with other families of circular luminaires.

Technical drawing

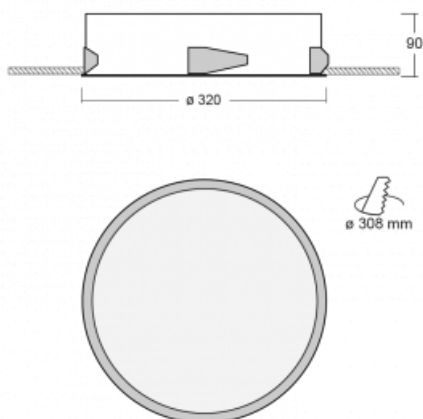

Type of installation	Recessed
Light distribution	Direct
Luminaire shape	Circular
Colour of the luminaires	White
Material	Aluminium
Lifetime	L80/B20 50 000 hours
Warranty	5 years
Description of luminaires	Luminaire recessed
Dimensions	ø 320 mm × 90 mm
Light source	LED MODUL
Type of optical system	Microprisma
Luminous flux*	1530 lm
Colour Temperature	4000 K cool white
Luminous efficacy	98 lm/W
MacAdam Light source	3
Colour rendering index	80
UGR max. X=4H Y=8H, ρ=70,50,20	19.9

Curve



Luminaire power input* 15.6 W

Connection of the luminaires DALI

Electrical voltage 220-240V

Frequency 50/60Hz

⊕ CE IP 20

*±10 %

Downloads

Installation instructions



Photos

