

Luminaire

Flumo100-S

128S-5E0I-060EE/830, W

Large spaces and long corridors – such places require something special: a linear aluminium profile that winds along the corridor in a perfect curve and navigates you through the space. The system luminaires of the Flumo100-S family will fully adapt to your possibilities and imagination. They can run straight or meander like the Colorado River. All the different lengths and angles mean that there are no limits. To assemble the Flumo100-S lighting system you can choose between the pendant and surface versions. They are available with an opal diffuser or microprism in a wide range of colours according to the Halla RAL chart. The luminaires can be controlled via Bluetooth technology from your smart device.

Type of installation	Suspended
Light distribution	Direct
Luminaire shape	Rounded
Colour of the luminaires	White
Material	Aluminium
Lifetime	L80/B20 50 000 hours
Warranty	5 years
Description of luminaires	Luminaire suspended
item description	R1250 - 60°
Dimensions (w × h mm)	100 mm × 87 mm
Diameter	∅ 1250
Angle	60 °
Light source	LED MODUL
DIR optical system	Microprisma
Luminous flux*	1530 lm
Colour Temperature	3000 K warm white
Luminous efficacy	83 lm/W
MacAdam Light source	3
Colour rendering index	80

Technical drawing

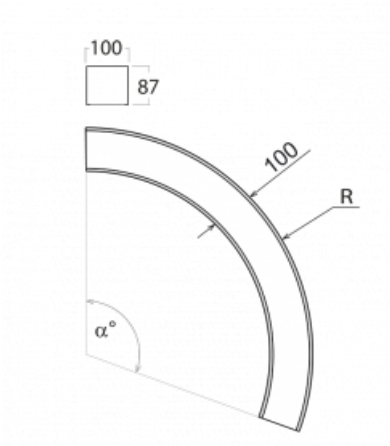

Luminaire power input* 18.5 W

Connection of the luminaires ON/OFF

Electrical voltage 220-240V

Frequency 50/60Hz

⊕ CE IP 20

* $\pm 10\%$

Curve

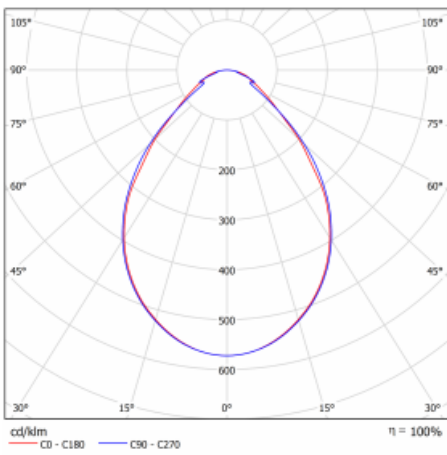

Downloads

Installation instructions



Photos

