

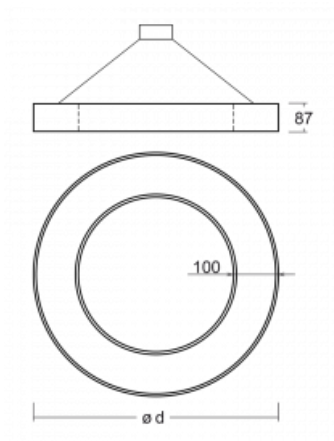

Luminaire

Rotao100

127-581I-10GEE/840, W

Technical drawing

Type of installation	Suspended
Light distribution	Direct-indirect
Luminaire shape	Circular
Colour of the luminaires	White
Material	Aluminium
Lifetime	L80/B20 50 000 hours
Warranty	5 years
Description of luminaires	Luminaire suspended
item description	White ceiling cup and cable
Dimensions	ø 850 mm × 87 mm
Weight	9.3 kg
Light source	LED MODUL
DIR optical system	Microprisma
INDIR optical system	Opal cover
Luminous flux*	3880 lm
Colour Temperature	4000 K cool white
Luminous efficacy	93 lm/W
MacAdam Light source	3
Colour rendering index	80
UGR max. X=4H Y=8H, ρ=70,50,20	16.5

Curve

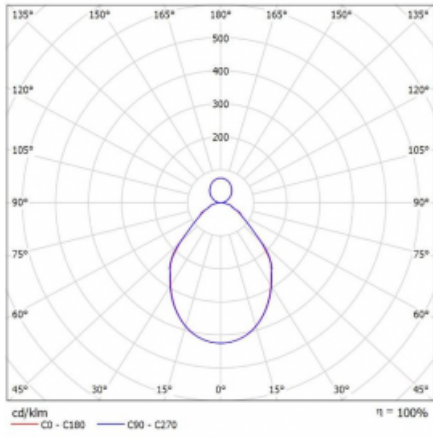

Luminaire power input* 41.5 W

Connection of the luminaires ON/OFF

Electrical voltage 220-240V

Frequency 50/60Hz

⊕ CE IP 20

*±10 %

Downloads

Installation instructions



Photos

