



Luminaire

Zuli

121-531M-20GEE/830, B



Do you remember the buzzing and flickering lights of your classroom? Fortunately these are long gone. Zuli pendant and surface-mounted LED luminaires ensure comfortable lighting in the classroom, offices and hospitals without these annoyances. These luminaires have direct or direct-indirect emission, with a choice of four lengths and microprism optics, grid and opal diffuser.

Technical drawing

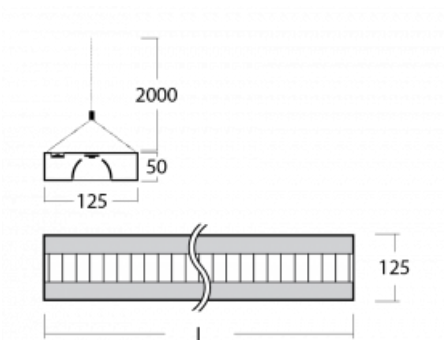

Type of installation	Suspended
Light distribution	Direct-indirect
Luminaire shape	Angular
Colour of the luminaires	Black
Material	Aluminium
Lifetime	L80/B20 50 000 hours
Warranty	5 years
Description of luminaires	Luminaire suspended
Dimensions	1145 mm × 125 mm × 50 mm
Weight	3.3 kg
Light source	LED MODUL
Type of optical system	Matt parabolic louvre
Luminous flux*	4110 lm
Colour Temperature	3000 K warm white
Luminous efficacy	123 lm/W
MacAdam Light source	2
Colour rendering index	80
UGR max. X=4H Y=8H, $\rho=70,50,20$	13.1

Curve



Luminaire power input* 33.4 W

Connection of the luminaires ON/OFF

Electrical voltage 220-240V

Frequency 50/60Hz

⊕ CE IP 20

*±10 %

Downloads

Installation instructions



Photos

