



Luminaire

Zuli

121-500I-25GGE/830, W



Do you remember the buzzing and flickering lights of your classroom? Fortunately these are long gone. Zuli pendant and surface-mounted LED luminaires ensure comfortable lighting in the classroom, offices and hospitals without these annoyances. These luminaires have direct or direct-indirect emission, with a choice of four lengths and microprism optics, grid and opal diffuser.

Technical drawing

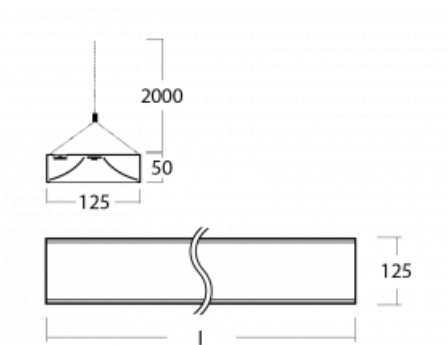

Type of installation	Suspended
Light distribution	Direct
Luminaire shape	Angular
Colour of the luminaires	White
Material	Aluminium
Lifetime	L80/B20 50 000 hours
Warranty	5 years
Description of luminaires	Luminaire suspended
item description	White ceiling cup and cable
Dimensions (l × w × h mm)	1425 mm × 125 mm × 50 mm
Weight	4.3 kg
Light source	LED MODUL
DIR optical system	Microprisma
Luminous flux*	3380 lm
Colour Temperature	3000 K warm white
Luminous efficacy	115 lm/W
MacAdam Light source	2
Colour rendering index	80
UGR max. X=4H Y=8H, ρ=70,50,20	18.7

Curve



Luminaire power input* 29.5 W

Connection of the luminaires ON/OFF

Electrical voltage 220-240V

Frequency 50/60Hz

⊕ CE IP 20

* $\pm 10\%$

Downloads

Installation instructions



Photos

