



Luminaire

Lina80-S

11S-501B-20GGE/830, S



EPD®

Lina80-S luminaires are available in recessed, surface, suspended or wall mounted versions, including the illuminated corner segments. Lina80-S system luminaire can be used to create different shapes or long lines, with special joints that prevent any light to shine through, creating thus a seamless visual effect, suitable for small offices as well as big halls.

Technical drawing

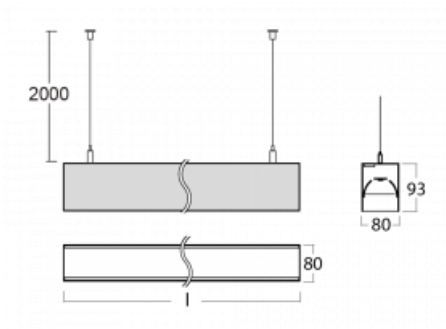

Type of installation Wall mounted, Suspended

Light distribution Direct-indirect

Luminaire shape Linear

Colour of the luminaires Silver

Material Aluminium

Lifetime L90/B50 50 000 hours

Warranty 5 years

Description of luminaires Luminaire wall mounted/suspended

Dimensions 1122 mm × 80 mm × 93 mm

Light source LED MODUL

Type of optical system MP PRO UGR

Luminous flux* 4630 lm

Colour Temperature 3000 K warm white

Luminous efficacy 129 lm/W

MacAdam Light source 2

Colour rendering index 80

UGR max. X=4H 16.9
Y=8H, $\rho=70,50,20$

Luminaire power input*	35.8 W
Connection of the luminaires	ON/OFF
Electrical voltage	220-240V
Frequency	50/60Hz

  IP 40

*±10 %

Downloads

Installation instructions



Photos



Accessories

00-00200, N
 straight connector

00-00300, N
 wire suspension
 2000mm

00-00301, N
 wire suspension
 4000mm

00-00302, N
 wire suspension
 6000mm

00-00352, K
 cable 3x0,75 2000mm

00-00355, K
 cable 5x0,75 2000mm

00-00356, K
 cable 5x0,75 4000mm

00-00358, K
 cable 3x0,75 4000mm

00-00360, K
 cable 3x0,75 6000mm

00-00363, K
 cable 5x1,5 2000mm

00-00364, K
 cable 5x1,5 4000mm

00-00365, K
 cable 5x1,5 6000mm

00-00370, S
 ceiling cup 80x80x32mm

00-01200, F
 Accessory for gear-tray
 release

00-20101, S
 2xend cap - metal, 5-
 conductor terminal box,
 grommet; Lipo80/Lina80

00-20103, S
 2xend cap - plastic, 5-
 conductor terminal box,
 grommet; Lipo80/Lina80

00-20700, S
 2 pcs of wall fastening
 Lipo/Lina

00-51300, S
 set for suspension into
 3-phase track, non-
 dimmable luminaires