



Luminaire

Lina80-S

11S-501B-10GGM3/840, B



EPD®

Lina80-S luminaires are available in recessed, surface, suspended or wall mounted versions, including the illuminated corner segments. Lina80-S system luminaire can be used to create different shapes or long lines, with special joints that prevent any light to shine through, creating thus a seamless visual effect, suitable for small offices as well as big halls.

Technical drawing

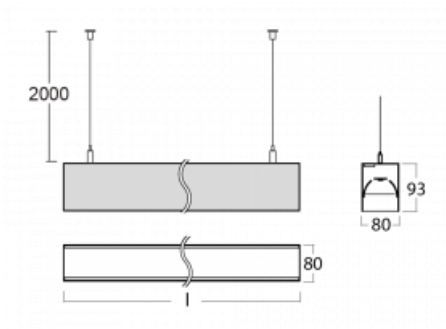

Type of installation	Wall mounted, Suspended
Light distribution	Direct-indirect
Luminaire shape	Linear
Colour of the luminaires	Black
Material	Aluminium
Lifetime	L90/B50 50 000 hours
Warranty	2 years
Description of luminaires	Luminaire wall mounted/suspended
Dimensions	561 mm × 80 mm × 93 mm
Light source	LED MODUL
Type of optical system	MP PRO UGR
Luminous flux*	2070 lm
Colour Temperature	4000 K cool white
Luminous efficacy	127 lm/W
MacAdam Light source	2
Colour rendering index	80
UGR max. X=4H Y=8H, ρ=70,50,20	16.5

Luminaire power input*	16.3 W
Connection of the luminaires	ON/OFF + 3h emergency
Electrical voltage	220-240V
Frequency	50/60Hz

  IP 40

*±10 %

Downloads

Installation instructions



Photos



Accessories

00-00200, N
 straight connector

00-00300, N
 wire suspension
 2000mm

00-00301, N
 wire suspension
 4000mm

00-00302, N
 wire suspension
 6000mm

00-00355, K
 cable 5x0,75 2000mm

00-00356, K
 cable 5x0,75 4000mm

00-00363, K
 cable 5x1,5 2000mm

00-00364, K
 cable 5x1,5 4000mm

00-00365, K
 cable 5x1,5 6000mm

00-00366, K
 cable 7x0,75 2000mm

00-00367, K
 cable 7x0,75 4000mm

00-00368, K
 cable 7x0,75 6000mm

00-00370, B
 ceiling cup 80x80x32mm

00-01200, F
 Accessory for gear-tray
 release

00-20101, B
 2xend cap - metal, 5-
 conductor terminal box,
 grommet; Lipo80/Lina80

00-20103, B
 2xend cap - plastic, 5-
 conductor terminal box,
 grommet; Lipo80/Lina80

00-20700, B
 2 pcs of wall fastening
 Lipo/Lina

00-51300, B
 set for suspension into
 3-phase track, non-
 dimmable luminaires