



Luminaire

Indi

108-541K-95FZD/830, S



Type of installation	Suspended
Light distribution	Direct-indirect
Luminaire shape	Circular
Colour of the luminaires	Silver
Material	Aluminium
Lifetime	L80/B20 50 000 hours
Warranty	5 years
Description of luminaires	Luminaire suspended

Dimensions	ø 3012 mm × 106 mm
Weight	22.8 kg
Light source	LED MODUL

Type of optical system	Opal diffuser
Luminous flux*	24000 lm
Colour Temperature	3000 K warm white
Luminous efficacy	83 lm/W
Colour rendering index	80
UGR max. X=4H Y=8H, $\rho=70,50,20$	19.9



The Indi luminaire, designed by Matúš Opálka, has won a number of awards, such as the Red Dot Award, the iF Design Award and the German Design Award. This circular luminaire directindirect distribution of light and dimensions from 1 to 4 meters can be used in meeting rooms, all types of corridors, conference halls and social spaces. The aluminium profile has been fitted with powerful LED boards. The indirect distribution of light on two sides creates a pleasant soft light with adjustable intensity.

Design Matúš Opálka

Technical drawing

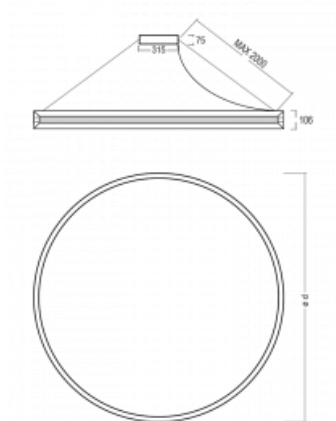

Curve

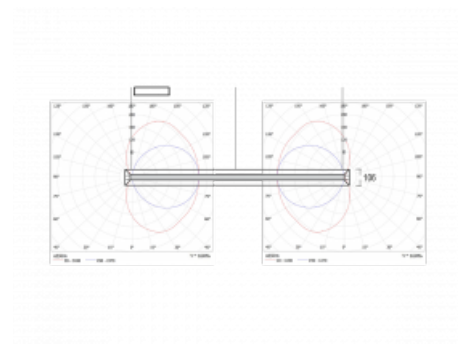

Luminaire power input* 288 W

Connection of the luminaires DALI

Electrical voltage 220-240V

Frequency 50/60Hz

⊕ CE IP 20

*±10 %

Downloads

Installation instructions



Photos



Accessories



108-0004
Tie-down strap for
INDI circle