



## Luminaire

# Lina80-S

05S-000K-10GEE/840, B



EPD®

Lina80-S luminaires are available in recessed, surface, suspended or wall mounted versions, including the illuminated corner segments. Lina80-S system luminaire can be used to create different shapes or long lines, with special joints that prevent any light to shine through, creating thus a seamless visual effect, suitable for small offices as well as big halls.

## Technical drawing

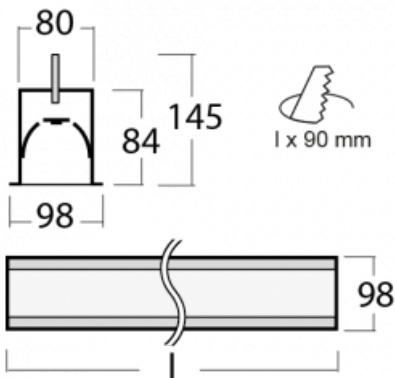

Type of installation	Recessed
Light distribution	Direct
Luminaire shape	Linear
Colour of the luminaires	Black
Material	Aluminium
Lifetime	L90/B50 60 000 hours
Warranty	5 years
Description of luminaires	Luminaire recessed
Dimensions	561 mm × 98 mm × 84 mm
Light source	LED MODUL
Type of optical system	Opal diffuser
Luminous flux*	1060 lm
Colour Temperature	4000 K cool white
Luminous efficacy	143 lm/W
MacAdam Light source	2
Colour rendering index	80
UGR max. X=4H Y=8H, ρ=70,50,20	23.5

Luminaire power input*	7.4 W
Connection of the luminaires	ON/OFF
Electrical voltage	220-240V
Frequency	50/60Hz

  IP 40

\*±10 %

## Downloads

Installation instructions



Photos



## Accessories



**00-00100, B**  
2xend cap - metal, 3-  
conductor terminal box,  
grommet; Lipo80



**00-00200, N**  
straight connector



**00-00500**  
wire for emergency  
lighting XX-XXXX-20



**00-01200, F**  
Accessory for gear-tray  
release