



## Luminaire

# Lina80

05-500I-80GEM/830, S



EPD®

Lina80 luminaires with an easy L-Click system feature an elegant and classic linear design with excellent illumination characteristics with both ceiling mounted and suspended versions, allowing them to fit into almost any space. Lina80 lighting is the right solution for offices, business, social and cultural spaces, as well as households and restaurants. With Tunable White, you set the white color temperature according to the time of day. The light thus provides optimal light helping you to focus on and concentrate on the work.

## Technical drawing

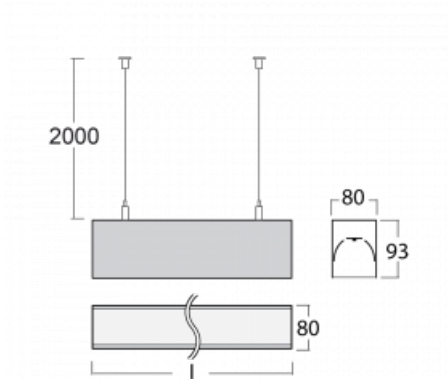

Type of installation	Suspended
Light distribution	Direct
Luminaire shape	Linear
Colour of the luminaires	Silver
Material	Aluminium
Lifetime	L90/B50 60 000 hours
Warranty	5 years
Description of luminaires	Luminaire suspended
Dimensions	4493 mm × 80 mm × 93 mm
Light source	LED MODUL
Type of optical system	Microprisma
Luminous flux*	3610 lm
Colour Temperature	3000 K warm white
Luminous efficacy	116 lm/W
MacAdam Light source	2
Colour rendering index	80
UGR max. X=4H Y=8H, ρ=70,50,20	16.6

Luminaire power input*	31.2 W
Connection of the luminaires	ON/OFF + 1h emergency
Electrical voltage	220-240V
Frequency	50/60Hz

  IP 40

\*±10 %

## Downloads

Installation instructions



Photos

