



Luminaire

Lina60-S

04S-000K-60GEE/830, W

EPD®

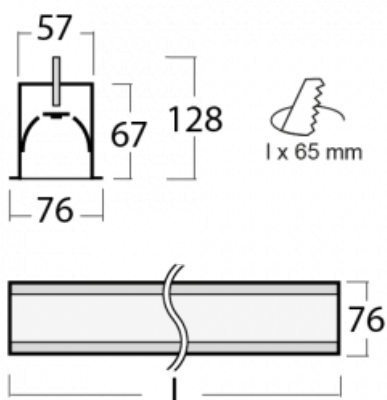
You will appreciate the L-Click system on the Lina60-S luminaire with a direct light distribution, which effectively saves you both time and money. How? The module simply clicks into the profile, so a lot of work is saved during assembly. This solution also prevents the direct touch of the LED technology and lengthens its operating life. The Lina60-S lighting system can be assembled creating endless lines and a big variety of shapes. In addition to great power output, the luminaire also has a great price. It will find its use in commercial, social and public spaces.

Technical drawing

Type of installation	Recessed
Light distribution	Direct
Luminaire shape	Linear
Colour of the luminaires	White
Material	Aluminium
Lifetime	L90/B50 50 000 hours
Warranty	5 years
Description of luminaires	Luminaire recessed
Dimensions	3366 mm × 76 mm × 67 mm
Weight	7.8 kg
Light source	LED MODUL
Type of optical system	Opal diffuser
Luminous flux*	6100 lm
Colour Temperature	3000 K warm white
Luminous efficacy	137 lm/W
MacAdam Light source	2
Colour rendering index	80
UGR max. X=4H Y=8H, $\rho=70,50,20$	24.9

Curve



Luminaire power input* 44.4 W

Connection of the luminaires ON/OFF

Electrical voltage 220-240V

Frequency 50/60Hz

⊕ CE IP 40

*±10 %

Downloads

Installation instructions



Photos



Accessories

00-00501
wire for emergency
lighting XX-XXXX-40



04-00100, W
2xend cap - metal, 3-
conductor terminal box,
grommet



04-00200, N
straight connector



04-01200, F
Accessory for gear-tray
release